

Customer ID: _____

ORDER FORM

 ORDER QUOTE

ICON 60

LIGHTWEIGHT, RIGID FRAME
WHEELCHAIR

Base model £ 1895.00

- Max user weight - 120kg
- Series 7000 Aluminium rigid active wheelchair
- Multiple of adjustments, Seat Depth, Front and Rear Seat Heights and Centre of Gravity
- Angle Adjustable Front Forks
- 24" Day Light Rear Wheel with back anodised hand rim, QR Axle and Pneumatic tyre
- 4" Alu Core Castor
- Lockdown Folding, Angle, Height and Tension Adjustable Backrest with 3D breathable Fabric and Seat cushion.
- Low Profile Scissor Lock Brakes
- Aluminium Side Guards
- Calf strap and under seat zipped pouch included

SUITABLE FOR USE WITH POWERED
ASSISTED WHEELCHAIR SYSTEMS



CE



Help to save paper and use the interactive PDF.
Please order by e-mail to ukadmin@rehasense.com. Thank's a lot.

Name:	Date:
Customer ID:	Order number:
Contact person:	Delivery address
E-Mail:	Str. & house nr:
Tel./Fax:	City & postcode:

PLEASE MARK TO SELECT AN OPTION

Hereby I consent to the processing of my personal data for the purpose of the order fulfilment for a rehabilitation equipment in accordance with Article 4 Paragraph 11 of the Regulation (EU) 2016/679 of the European Parliament and of the Council of 27 April 2016 on the protection of natural persons with regard to the processing of personal data and on the free movement of such data, and repealing Directive 95/46/EC (General Data Protection Regulation)

I am aware of the fact that all dimensions can be provided within the dimensional tolerance of ± 1 cm. A dimensional deviation within this tolerance range shall not constitute a reason to claim the wheelchair and deem it non-compliant with this contract.

SEAT WIDTH				
tick to order	Part number	Description	Standard or cost option	Price
<input type="radio"/>	SW36	Seat width 36 cm	Standard	£ 0,00
<input type="radio"/>	SW38	Seat width 38 cm	Standard	£ 0,00
<input type="radio"/>	SW40	Seat width 40 cm	Standard	£ 0,00
<input type="radio"/>	SW42	Seat width 42 cm	Standard	£ 0,00
<input type="radio"/>	SW44	Seat width 44 cm	Standard	£ 0,00
<input type="radio"/>	SW46	Seat width 46 cm	Standard	£ 0,00
<input type="radio"/>	SW48	Seat width 48 cm	Standard	£ 0,00

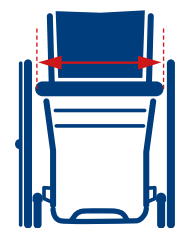

SEAT DEPTH				
<input type="radio"/>	SD40	Seat depth 40 cm	Standard	£ 0,00
<input type="radio"/>	SD41.5	Seat depth 41.5 cm	Standard	£ 0,00
<input type="radio"/>	SD43	Seat depth 43 cm	Standard	£ 0,00
<input type="radio"/>	SD44.5	Seat depth 44.5 cm	Standard	£ 0,00
<input type="radio"/>	SD46	Seat depth 46 cm	Standard	£ 0,00
<input type="radio"/>	SD47.5	Seat depth 47.5 cm	Standard	£ 0,00
<input type="radio"/>	SD49	Seat depth 49 cm	Standard	£ 0,00

Seat range adjustable between 40 cm - 49 cm

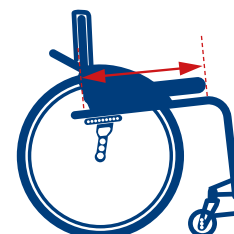

FRONT SEAT HEIGHT				
<input type="radio"/>	SH50	Seat High Front 50 cm	Standard	£ 0,00
<input type="radio"/>	SH49	Seat High Front 49 cm	Standard	£ 0,00
<input type="radio"/>	SH47	Seat High Front 47.5 cm	Standard	£ 0,00

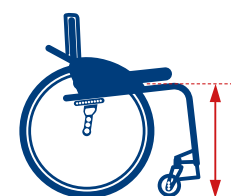

REAR SEAT HEIGHT				
<input type="radio"/>	RSH1	Position 1: 38.5 cm	Standard	£ 0,00
<input type="radio"/>	RSH2	Position 2: 41 cm	Standard	£ 0,00
<input type="radio"/>	RSH3	Position 3: 44.5 cm	Standard	£ 0,00

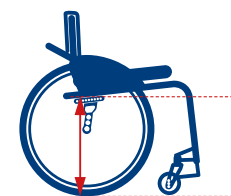

LOWER LEG LENGTH (FOOTREST POSITION)				
<input type="radio"/>	LLL1	Position 1: 41.5 cm	Option	£ 0,00
<input type="radio"/>	LLL2	Position 2: 43 cm	Standard	£ 0,00
<input type="radio"/>	LLL3	Position 3: 44.5 cm	Option	£ 0,00
<input type="radio"/>	LLL4	Position 4: 46 cm	Option	£ 0,00

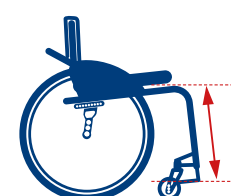

SEAT POSITION (BALANCE)

<input type="radio"/>	SP1	Position 1 = +7.5 cm Most Active	Option	£ 0,00
<input type="radio"/>	SP2	Position 2 = + 6 cm	Option	£ 0,00
<input type="radio"/>	SP3	Position 3 = + 4.5 cm	Option	£ 0,00
<input type="radio"/>	SP4	Position 4 = + 3 cm	Standard	£ 0,00
<input type="radio"/>	SP5	Position 5 = +1.5 cm	Option	£ 0,00
<input type="radio"/>	SP6	Position 6 = 0	Option	£ 0,00
<input type="radio"/>	SP7	Position 7 = -1.5 cm	Option	£ 0,00
<input type="radio"/>	SP8	Position 8 = -3 cm Least Active	Option	£ 0,00

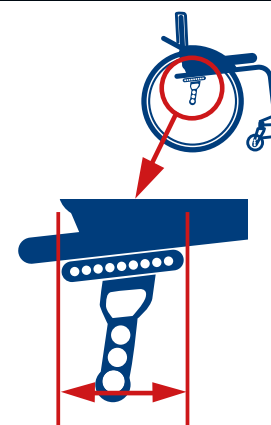

BACKREST ANGLE

<input type="radio"/>	BRA1	Forward +1 → +20°	Option	£ 0,00
<input type="radio"/>	BRA2	Backward -10 → 0°	Standard	£ 0,00

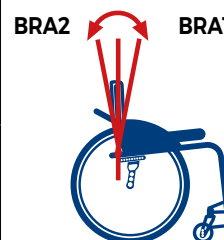

BACKREST OPTIONS

<input type="radio"/>	BRO1	Height adjustable backrest without push handles	Standard	£ 0,00
<input type="radio"/>	BRO2	Height adjustable backrest fitted with height adjustable push handles	Option	£ 160,00
<input type="radio"/>	BRO3	Height adjustable backrest fitted with ergonomic backrest frame	Option	£ 140,00
<input type="radio"/>	BRO4	Height adjustable backrest fitted with ergonomic backrest frame and height adjustable push handles	Option	£ 160,00
<input type="radio"/>	BRO5	Height adjustable, standard backrest without push handles width adjustable between -3 to +3cm	Option	£ 140,00
<input type="radio"/>	BRO6	Height adjustable, standard backrest without push handles width adjustable between -7 to +7cm	Option	£ 140,00



BRO1
Height adjustable backrest without push handles

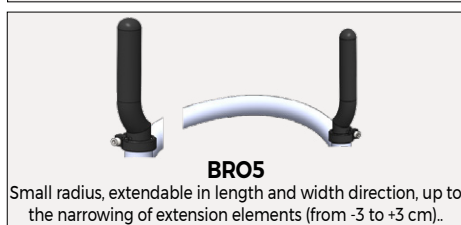
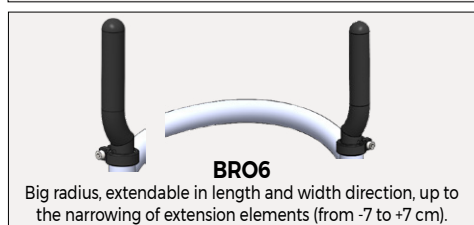
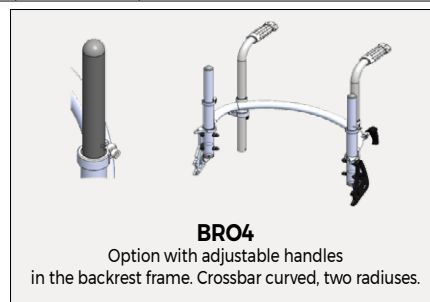
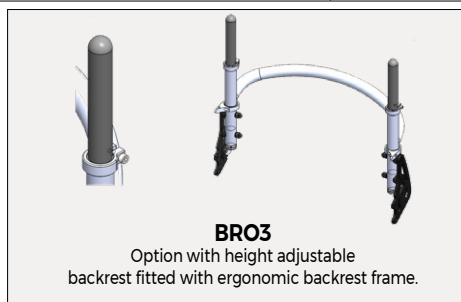

BACKREST HEIGHT (CM)

<input type="radio"/> 32 standard		
<input type="radio"/> 33	<input type="radio"/> 34	<input type="radio"/> 35
<input type="radio"/> 36	<input type="radio"/> 37	<input type="radio"/> 38



BACKREST OPTIONS

<input type="radio"/>	BRH1	Backrest with foldable pushhandles, single bended crossbar, frame height 25cm +6cm with handle (31cm)	Option	£ 100,00	 
<input type="radio"/>	BRH2	Backrest with foldable pushhandles, single bended crossbar, frame height 30cm +6cm with handle (36cm)	Option	£ 100,00	
<input type="radio"/>	BRH3	Backrest with foldable pushhandles, single bended crossbar, frame height 35cm +6cm with handle (41cm)	Option	£ 100,00	
<input type="radio"/>	BRH4	Backrest with foldable pushhandles, double bended crossbar, frame height 25cm +6cm with handle (31cm)	Option	£ 100,00	 
<input type="radio"/>	BRH5	Backrest with foldable pushhandles, double bended crossbar, frame height 30cm +6cm with handle (36cm)	Option	£ 100,00	
<input type="radio"/>	BRH6	Backrest with foldable pushhandles, double bended crossbar, frame height 35cm +6cm with handle (41cm)	Option	£ 100,00	

Backrest height non-extendable, for folding handles in the backrest frame.

Backrest height non-extendable, for folding handles in the backrest frame. Crossbar curved, two radiuses



FOOTREST

<input type="radio"/>	FR1	Standard footrest	Standard	£ 0,00		
<input type="radio"/>	FR2	Reinforced footrest for track wheel	Option	£ 75,00		

FR1

FR2

SIDE PANELS





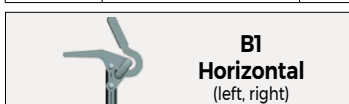

<input type="radio"/>	SP1	Aluminium side panel, flat, swing away	Standard	£ 0,00	
<input type="radio"/>	SP2	Carbon side panel, flat, swing away	Option	£ 130,00	
<input type="radio"/>	SP3	Side panel with armrest cushion	Option		

BRAKES



<input type="radio"/>	B1	Horizontal (left, right)	Option	£ 65,00	
<input type="radio"/>	B2	Horizontal Premium Lock-P (L+R)	Standard	£ 0,00	
<input type="radio"/>	B3	Horizontal Lock-A in aluminium	Option	£ 110,00	



FRAME COLOUR

<input type="radio"/>	FC1	White	Option	£ 0,00	     
<input type="radio"/>	FC2	Black Matt	Standard	£ 0,00	
<input type="radio"/>	FC3	Silver	Option	£ 0,00	
<input type="radio"/>	FC4	Gold	Option	£ 40,00	
<input type="radio"/>	FC5	Blue	Option	£ 40,00	
<input type="radio"/>	FC6	Red	Option	£ 40,00	

FORKS

<input type="radio"/>	F1	Standard Light	Standard	£ 0,00		
<input type="radio"/>	F2	Jazz-Shock	Option	£ 330,00		

FRONT WHEELS

<input type="radio"/>	FW1	Alucore - 4" 100x34 mm rim anodised, Silver coloured	Standard	£ 0,00	 <p>FW1 Alucore - 4" 100x34 mm rim anodised, Silver coloured</p>
<input type="radio"/>	FW2	Alucore - 4" 100x34 mm rim anodised, black coloured	Standard	£ 0,00	
<input type="radio"/>	FW3	Alucore - 5" 125x34 mm rim anodised, silver coloured	Option	£ 50,00	
<input type="radio"/>	FW4	Alucore - 5" 125x34 mm rim anodised, black coloured	Option	£ 50,00	
<input type="radio"/>	FW5	Tristar - 4" 100x34 mm rim anodised, silver coloured	Option	£ 75,00	
<input type="radio"/>	FW6	Tristar - 5" 125x34 mm rim anodised, silver coloured	Option	£ 75,00	
<input type="radio"/>	FW7	Lotus fibercore - 4" 100x34 mm rim plastic, black	Option	£ 75,00	
<input type="radio"/>	FW8	Lotus fibercore - 5" 125x34 mm rim plastic, black	Option	£ 75,00	

 <p>FW2 Alucore - 4", 100 X 34 mm, rim anodised, black</p>	 <p>FW3 Alucore - 5", 125 X 34 mm rim anodised, silver</p>	 <p>FW4 Alucore - 5", 125 X 34 mm rim anodised, black</p>	 <p>FW5 Tristar - 4" 100x34 mm rim anodised, silver</p>	 <p>FW6 Tristar - 5" 125x34 mm rim anodised, silver</p>	 <p>FW7 Lotus fibercore - 4" 100x34 mm rim plastic, black</p>	 <p>FW8 Lotus fibercore - 5" 125x34 mm rim plastic, black</p>
--	--	---	---	--	---	---

REAR WHEELS

<input type="radio"/>	RW1	DAYLITE - 24" x 1" wheel (Tyre: T1, T2, T3; Pushrim: PR1, PR2, PR3, PR4, PR5, PR6, PR7, PR8)	Standard	£ 0,00	 <p>RW1 DAYLITE 930S 24" wheel/2 pcs.</p>
<input type="radio"/>	RW2	SKYLITE - 24" x 1" wheel (Tyres: T1, T2, T3; Pushrim: PR1, PR2, PR3, PR4, PR5, PR6, PR7, PR8)	Option	£ 220,00	
<input type="radio"/>	RW3	TENSIO SPIRIT fibre glass 24" x 1" wheel (Tyres: T1, T2, T3; Pushrim: PR1, PR2, PR3, PR4, PR5, PR6, PR7, PR8)	Option	£ 410,00	
<input type="radio"/>	RW4	HURRICANE 24" x 1" Wheel (Tyres: T1, T2, T3; Pushrim: PR1, PR2, PR3, PR4, PR5, PR6, PR7, PR8)	Option	£ 410,00	
<input type="radio"/>	RW5	OFF ROAD 24" x 2" buddy wheel (Tyres: T4; Pushrim: PR2, PR7)	Option	£ 550,00	
<input type="radio"/>	RW6	SMARTLITE 24" wheel	Option	£ 0,00	

 <p>RW2 SKYLITE 930S 24" wheel/2 pcs.</p>	 <p>RW3 TENSIO SPIRIT glass fibre 24" wheel/ hub polished aluminium</p>	 <p>RW4 HURRICANE 24" wheel</p>	 <p>RW5 OFF ROAD 24" BUDDY wheel</p>	 <p>RW6 SMARTLITE 24" wheel</p>
---	---	---	---	---

TYRES					
<input type="radio"/>	T1	Speedlite 24" x 1"	Standard	£ 0,00	 <p>T1 Speedlite 24"</p>
<input type="radio"/>	T2	Gazelle 24" x 1"	Option	£ 50,00	
<input type="radio"/>	T3	Trailblazer 24" x 1"	Option	£ 80,00	
<input type="radio"/>	T4	Schwalbe Big Apple (only to be used with 24" Buddy)	Option	£ 80,00	



PUSH RIMS					
<input type="radio"/>	PR1	Anodised aluminium, Black - coloured	Standard	£ 0,00	 <p>PR1 Anodised aluminium, Black - coloured</p>
<input type="radio"/>	PR2	Anodised aluminium, Silver - coloured	Option	£ 0,00	
<input type="radio"/>	PR3	Steel	Option	£ 70,00	
<input type="radio"/>	PR4	Titanium	Option	£ 175,00	
<input type="radio"/>	PR5	Tetra Optimum F	Option	£ 200,00	
<input type="radio"/>	PR6	Tetra Tour H	Option	£ 200,00	
<input type="radio"/>	PR7	Tetra silicone, Black	Option	£ 85,00	
<input type="radio"/>	PR8	Nova H	Option	£ 210,00	

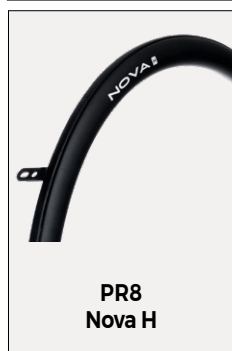

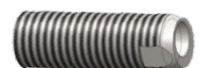

CAMBER REAR WHEELS					
<input type="radio"/>	CRW0	Camber 0	Option	£ 0,00	
<input type="radio"/>	CRW1	Camber 1	Option	£ 0,00	
<input type="radio"/>	CRW2	Camber 2	Standard	£ 0,00	
<input type="radio"/>	CRW3	Camber 3	Option	£ 0,00	

BUSHING TYPE					
<input type="radio"/>	BT1	Metric 12 mm	Option	£ 0,00	
<input type="radio"/>	BT2	Inch 1/2"	Standard	£ 0,00	

QR AXLES					
<input type="radio"/>	QR1	Quick release axle / 2pcs	Standard	£ 0,00	 QR1
<input type="radio"/>	QR2	Quick release tetra handle axle / 2pc	Option	£ 120,00	



OPTIONS					
<input type="radio"/>	O1	Anti-Tip Left	Option	£ 120,00	
<input type="radio"/>	O2	Anti-Tip Right	Option	£ 120,00	
<input type="radio"/>	O3	Tip-on Left	Option		
<input type="radio"/>	O3	Tip-on Right	Option		

TRACK WHEEL					 STWA, STWC	 DTWC
<input type="radio"/>	STWA	Single arm track wheel Aluminium	Option	£ 385,00		
<input type="radio"/>	STWC	Single arm track wheel Carbon	Option	£ 499,00		
<input type="radio"/>	DTWC	Double arm track wheel Carbon	Option	£ 599,00		

Your notes

Technical Data will vary according to the frame dimensions chosen and the way the wheelchair is set up (front and rear wheels). The data in the table refers to a Seat Width of 40 cm and a Seat Depth of 42 cm. All measurements are in centimeters (cm) for distance and kilograms (kg) for weight, unless otherwise stated.